

Description

The 1.5KE Series is designed specifically to protect sensitive electronic equipment from voltage transients induced by lightning and other transient voltage events

Applications

- Communication Equipment
- Security & Protection
- Industrial Control Equipment
- Power Supply
- Automotive Electronics
- New Energy
- Lightning Protection

Functional Diagram

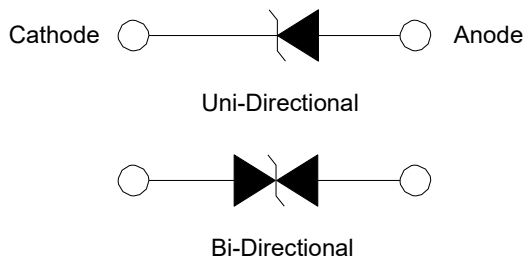

Features

- 1500 W peak pulse capability at 10/1000 μ s waveform, repetition rate (duty cycles):0.01%
- Glass passivated chip junction or Planar chip (< 10 V) in DO-201 Package
- Fast response time: typically less than 1.0 PS from 0 Volts to BV min
- Excellent clamping capability
- Typical failure mode is short from over-specified voltage or current
- Whisker test is conducted based on JEDEC JESD201A per its table 4a and 4c
- IEC-61000-4-2 ESD 30 kV (Air), 30 kV (Contact)
- ESD protection of data lines in accordance with IEC 61000-4-2
- EFT protection of data lines in accordance with IEC 61000-4-4
- Low incremental surge resistance
- Typical I_R less than 1 μ A when V_{BR} min>12 V
- High temperature to reflow soldering guaranteed: 260 $^{\circ}$ C/30 sec / 0.375", (9.5 mm) lead length, 5 lbs., (2.3 kg) tension
- V_{BR} @ T_J = $V_{BR}@25^{\circ}$ C x (1+ α T x (T_J - 25)) (α T: Temperature Coefficient, typical value is 0.1%)
- Plastic package is flammability rated V-0 per Underwriters Laboratories
- Matte tin lead-free plated
- Halogen free and RoHS compliant
- Pb-free E3 means 2nd level interconnect is Pb-free and the terminal finish material is tin(Sn) (IPC/JEDEC J-STD-609A.01)

Package Outline Dimensions (DO-201)

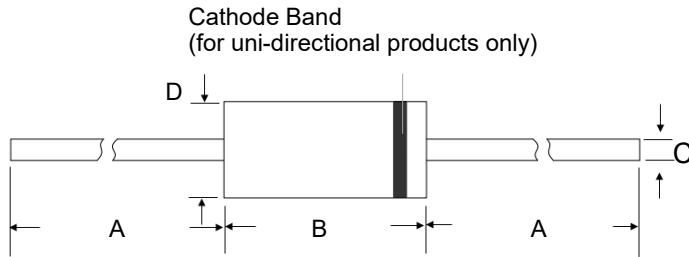

DO - 201

Symbol	Millimeters		Inches	
	Min.	Max.	Min.	Max.
A	25.4	-	1.000	-
B	7.20	9.50	0.285	0.375
C	0.96	1.07	0.038	0.042
D	4.80	5.30	0.190	0.210

Maximum Ratings and Characteristics

($T_A = 25\text{ }^\circ\text{C}$ unless otherwise specified.)

Parameter	Symbol	Value	Unit
Peak Pulse Power Dissipation(Fig.2) by 10/1000 us Test Waveform(Fig.4) (Note 1) -Single Die Parts	P_{PPM}	1500	W
Peak Pulse Power Dissipation(Fig.2) by 10/1000 us Test Waveform(Fig.4) (Note 1) -Stacked Die Parts (Note 4)	P_{PPM}	2000	W
Steady State Power Dissipation on Infinite Heat Sink at $T_L=75\text{ }^\circ\text{C}$	P_D	6.5	W
Peak Forward Surge Current, 8.3 ms Single Half Sine Wave Unidirectional Only (Note 2)	I_{FSM}	200	A
Maximum Instantaneous Forward Voltage at 100 A for Unidirectional Only (Note 3)	V_F	3.5/5.0	V
Operating Junction and Storage Temperature Range	T_J, T_{STG}	-55 to 175	$^\circ\text{C}$
Typical Thermal Resistance Junction to Lead	$R_{\theta JL}$	15	$^\circ\text{C} / \text{W}$
Typical Thermal Resistance Junction to Ambient	$R_{\theta JA}$	75	$^\circ\text{C} / \text{W}$

Notes

1. Non-repetitive current pulse, per Fig. 4 and derated above T_J (initial)= $25\text{ }^\circ\text{C}$ per Fig. 3.
2. Measured of 8.3 ms single half sine-wave or equivalent square wave, duty cycle=4 pulses per minute maximum.
3. $V_F < 3.5\text{ V}$ for single die parts and $V_F < 5.0\text{ V}$ for stacked-die parts.
4. For stacked die component details, please refer to part numbers labeled by * in Electrical Characteristics.

Part Numbering System

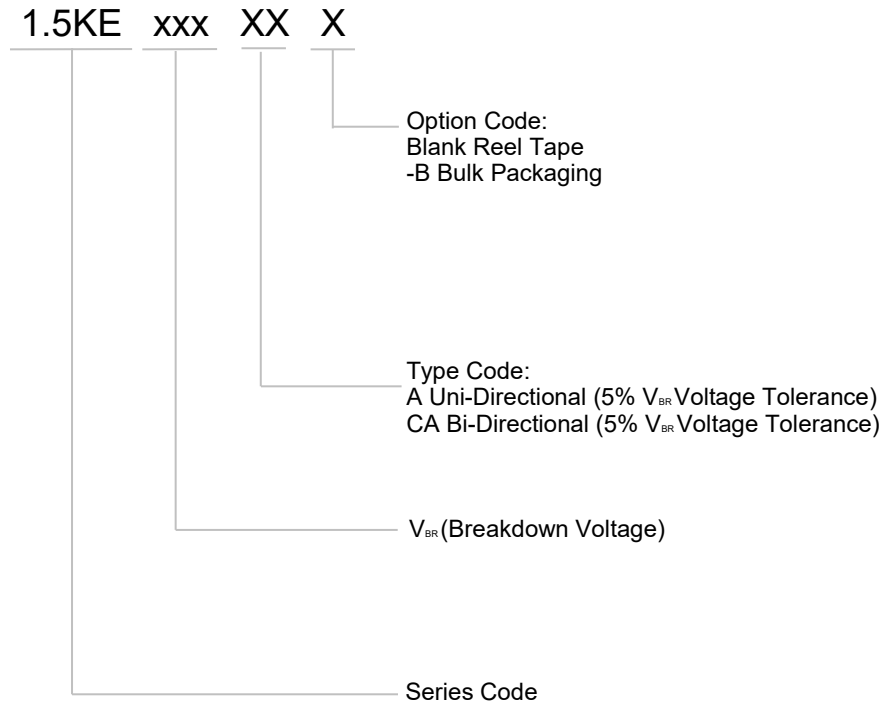

Marking

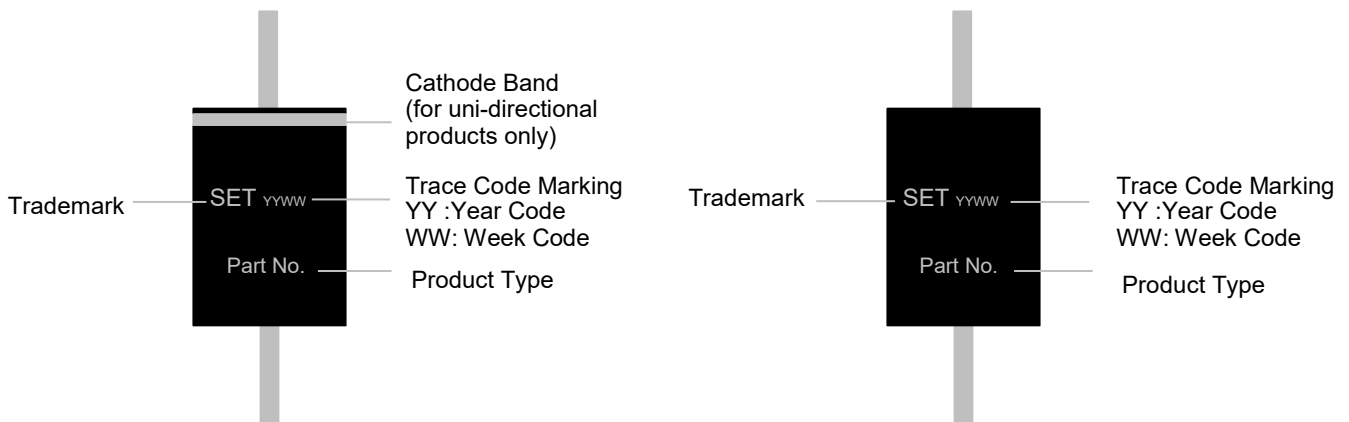

Electrical Characteristics (T_A=25 °C unless otherwise noted)

Part Number		Breakdown Voltage V _{BR@I_T}		Test Current I _T	Reverse Stand-off Voltage V _R	Max. Reverse Leakage I _{R@V_R}	Max. Peak Pulse Current I _{PPM}	Max. Clamping Voltage V _{C@I_{PPM}}
		Min	Max					
Uni	Bi	(V)		(mA)	(V)	(μA)	(A)	(V)
1.5KE6.8A	1.5KE6.8CA	6.45	7.14	10	5.80	1000.00	144.80	10.50
1.5KE7.5A	1.5KE7.5CA	7.13	7.88	10	6.40	500.00	134.50	11.30
1.5KE8.2A	1.5KE8.2CA	7.79	8.61	10	7.02	200.00	125.60	12.10
1.5KE9.1A	1.5KE9.1CA	8.65	9.50	1	7.78	50.00	113.40	13.40
1.5KE10A	1.5KE10CA	9.50	10.50	1	8.55	10.00	104.80	14.50
1.5KE11A	1.5KE11CA	10.50	11.60	1	9.40	5.00	97.40	15.60
1.5KE12A	1.5KE12CA	11.40	12.60	1	10.20	5.00	91.00	16.70
1.5KE13A	1.5KE13CA	12.40	13.70	1	11.10	1.00	83.50	18.20
1.5KE15A	1.5KE15CA	14.30	15.80	1	12.80	1.00	71.70	21.20
1.5KE16A	1.5KE16CA	15.20	16.80	1	13.60	1.00	67.60	22.50
1.5KE18A	1.5KE18CA	17.10	18.90	1	15.30	1.00	60.30	25.20
1.5KE20A	1.5KE20CA	19.00	21.00	1	17.10	1.00	54.90	27.70
1.5KE22A	1.5KE22CA	20.90	23.10	1	18.80	1.00	49.70	30.60
1.5KE24A	1.5KE24CA	22.80	25.20	1	20.50	1.00	45.80	33.20
1.5KE27A	1.5KE27CA	25.70	28.40	1	23.10	1.00	40.50	37.50
1.5KE30A	1.5KE30CA	28.50	31.50	1	25.60	1.00	36.70	41.40
1.5KE33A	1.5KE33CA	31.40	34.70	1	28.20	1.00	33.30	45.70
1.5KE36A	1.5KE36CA	34.20	37.80	1	30.80	1.00	30.50	49.90
1.5KE39A	1.5KE39CA	37.10	41.00	1	33.30	1.00	28.20	53.90
1.5KE43A	1.5KE43CA	40.90	45.20	1	36.80	1.00	25.60	59.30
1.5KE47A	1.5KE47CA	44.70	49.40	1	40.20	1.00	23.50	64.80
1.5KE51A	1.5KE51CA	48.50	53.60	1	43.60	1.00	21.70	70.10
1.5KE56A	1.5KE56CA	53.20	58.80	1	47.80	1.00	19.70	77.00
1.5KE62A	1.5KE62CA	58.90	65.10	1	53.00	1.00	17.90	85.00
1.5KE68A	1.5KE68CA	64.60	71.40	1	58.10	1.00	16.50	92.00

Part Number		Breakdown Voltage $V_{BR@I_T}$		Test Current I_T	Reverse Stand-off Voltage V_R	Max. Reverse Leakage $I_R@V_R$	Max. Peak Pulse Current I_{PPM}	Max. Clamping Voltage $V_C@I_{PPM}$
		Min	Max					
Uni	Bi	(V)		(mA)	(V)	(μ A)	(A)	(V)
1.5KE75A	1.5KE75CA	71.30	78.80	1	64.10	1.00	14.80	103.00
1.5KE82A	1.5KE82CA	77.90	86.10	1	70.10	1.00	13.50	113.00
1.5KE91A	1.5KE91CA	86.50	95.50	1	77.80	1.00	12.20	125.00
1.5KE100A	1.5KE100CA	95.00	105.00	1	85.50	1.00	11.10	137.00
1.5KE110A	1.5KE110CA	105.00	116.00	1	94.00	1.00	10.00	152.00
1.5KE120A	1.5KE120CA	114.00	126.00	1	102.00	1.00	9.20	165.00
1.5KE130A	1.5KE130CA	124.00	137.00	1	111.00	1.00	8.50	179.00
1.5KE150A	1.5KE150CA	143.00	158.00	1	128.00	1.00	7.30	207.00
1.5KE160A	1.5KE160CA	152.00	168.00	1	136.00	1.00	6.90	219.00
1.5KE170A	1.5KE170CA	162.00	179.00	1	145.00	1.00	6.50	234.00
1.5KE180A	1.5KE180CA	171.00	189.00	1	154.00	1.00	6.20	246.00
1.5KE200A	1.5KE200CA	190.00	210.00	1	171.00	1.00	5.50	274.00
1.5KE220A	1.5KE220CA	209.00	231.00	1	185.00	1.00	4.60	328.00
1.5KE250A	-	237.00	263.00	1	214.00	1.00	4.40	344.00
-	1.5KE250CA*	237.00	263.00	1	214.00	1.00	5.90	344.00
1.5KE300A*	1.5KE300CA*	285.00	315.00	1	256.00	1.00	4.90	414.00
1.5KE320A*	1.5KE320CA*	304.00	336.00	1	273.00	1.00	4.60	441.00
1.5KE350A*	1.5KE350CA*	332.00	368.00	1	300.00	1.00	4.20	482.00
1.5KE400A*	1.5KE400CA*	380.00	420.00	1	342.00	1.00	3.70	548.00
1.5KE440A*	1.5KE440CA*	418.00	462.00	1	376.00	1.00	3.10	602.00
1.5KE480A*	1.5KE480CA*	456.00	504.00	1	408.00	1.00	3.10	658.00
1.5KE510A*	1.5KE510CA*	485.00	535.00	1	434.00	1.00	2.90	698.00
1.5KE530A*	1.5KE530CA*	503.50	556.50	1	451.00	1.00	2.80	725.00
1.5KE540A*	1.5KE540CA*	513.00	567.00	1	460.00	1.00	2.80	740.00
1.5KE550A*	1.5KE550CA*	522.50	577.50	1	468.00	1.00	2.70	760.00
1.5KE600A*	1.5KE600CA*	570.00	630.00	1	512.00	1.00	2.50	828.00

Notes:

1. Measured of 8.3 ms single half sine-wave or equivalent square wave, duty cycle=4 pulses per minute maximum.
2. $V_F < 3.5$ V for single die parts and $V_F < 5.0$ V for stacked-die parts.
3. For stacked die component details, please refer to models marked with * in electrical characteristics table.
4. For bidirectional type having V_R of 10 volts and less, the I_R should be doubled.

I-V Curve Characteristics

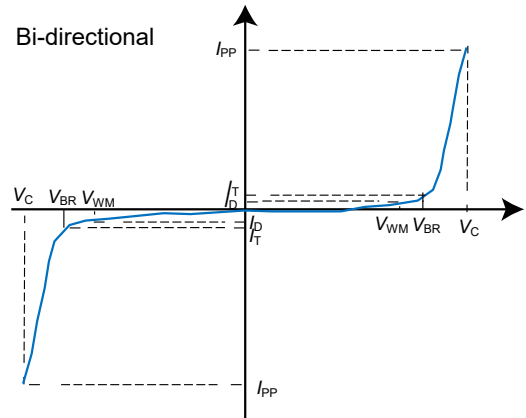
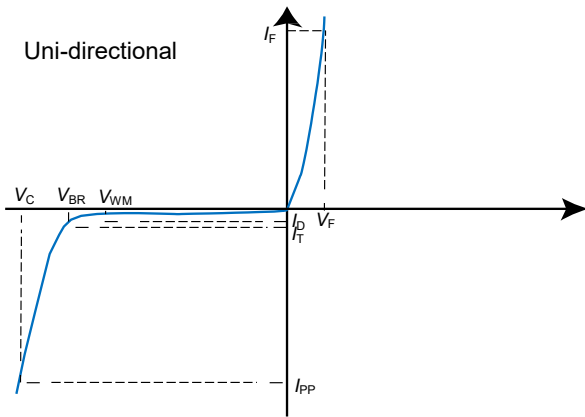

Performance Curve for Reference ($T_A=25^\circ\text{C}$ unless otherwise noted)

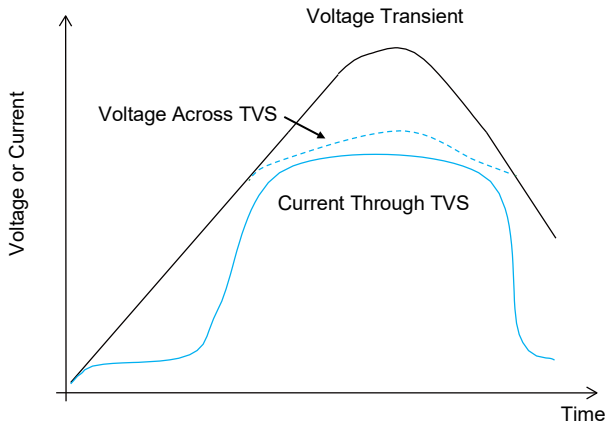

FIGURE 1 TVS Transients Clamping Waveform

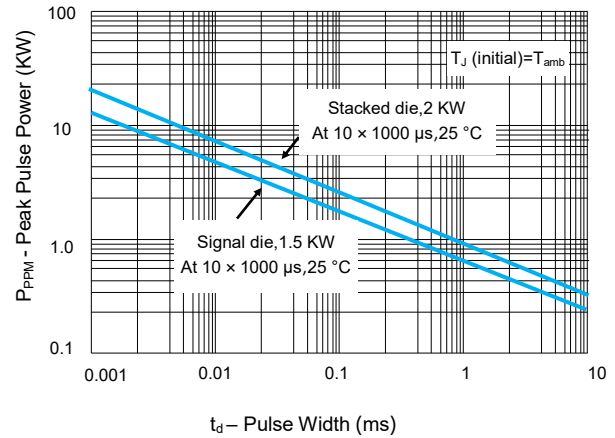

FIGURE 2 Peak Pulse Power Rating Curve

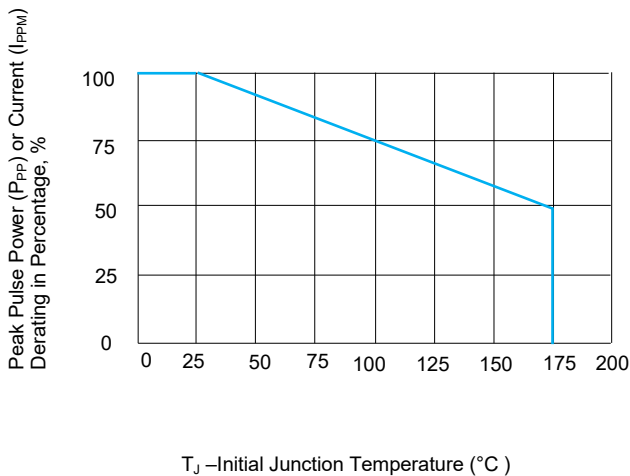

FIGURE 3 Peak Pulse Power Derating Curve

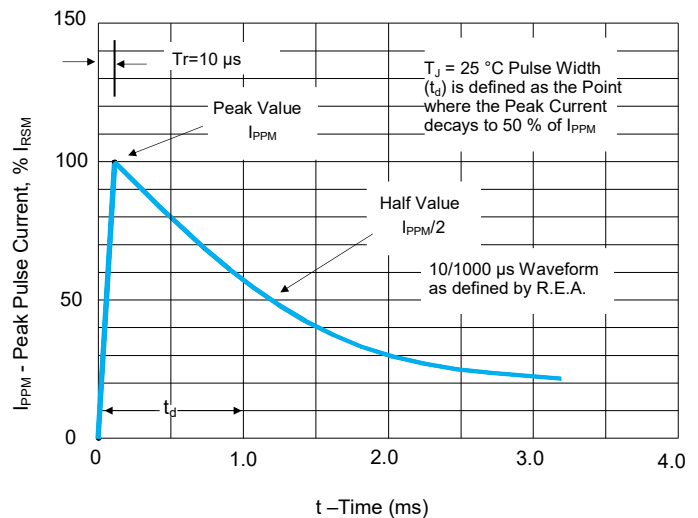

FIGURE 4 Pulse Waveform

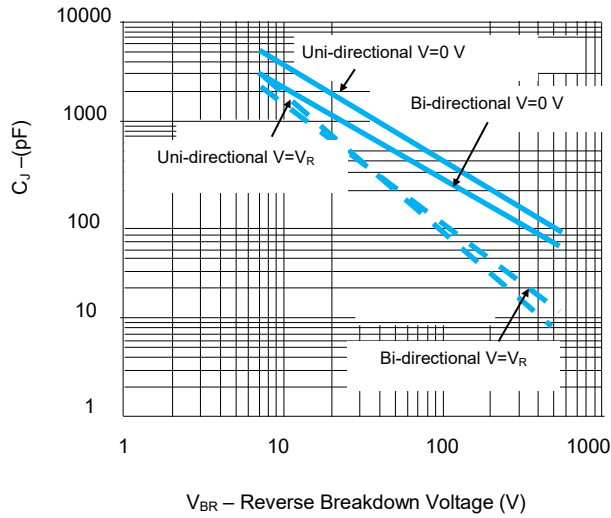

FIGURE 5 Typical Junction Capacitance

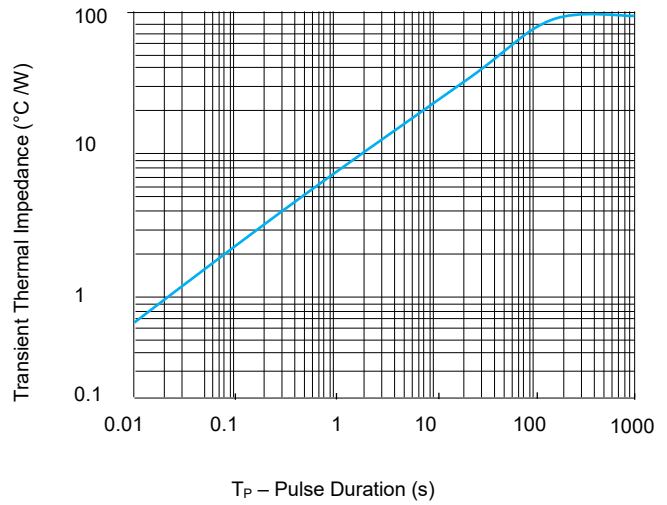

FIGURE 6 Typical Transient Thermal Impedance

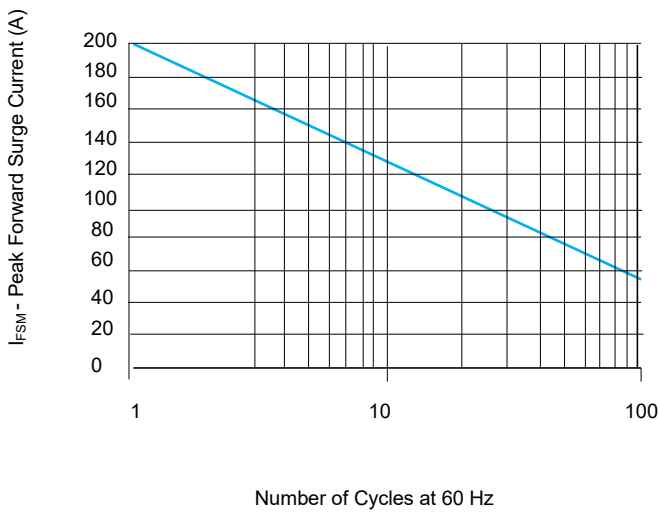

FIGURE 7 Maximum Non-Repetitive Forward Surge Current
Uni-Directional only

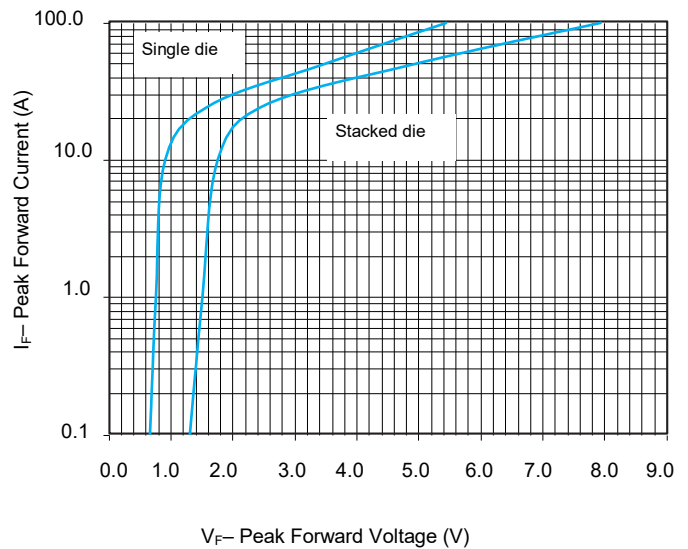

FIGURE 8 Peak Forward Drop vs Peak Forward Current
(Typical Values)

Environmental Specifications

High Temp. Storage	JESD22-A103
HTRB	JESD22-A108
Temperature Cycling	JESD22-A104
H3TRB	JESD22-A101
RSH	JESD22-B106

Physical Specifications

Weight	0.045 oz., 1.2 g
Case	JEDEC DO-201 molded plastic body over passivated junction
Polarity	Color band denotes the cathode except Bipolar.
Terminal	Matte Tin-plated leads, Solderability per JESD22-B102

Soldering Parameters

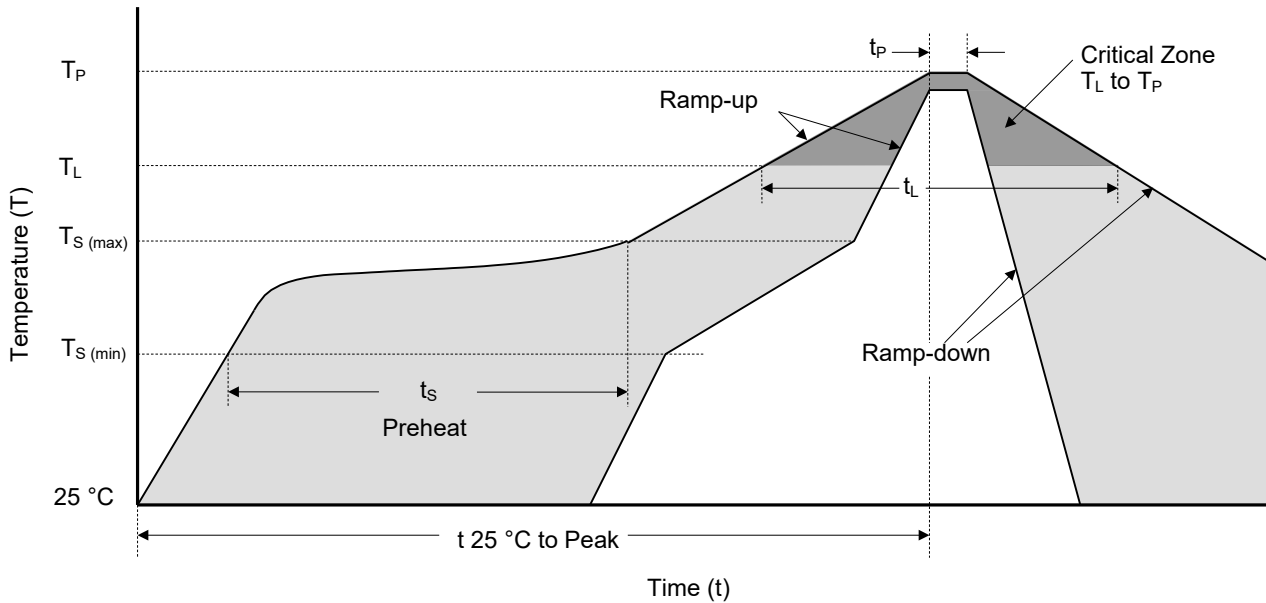

Reflowing Condition

Reflow Soldering Parameters		Lead-Free Assembly
Pre-heat	Temperature Min ($T_{S (min)}$)	150 °C
	Temperature Max ($T_{S (max)}$)	200 °C
	Time (min to max) (t_s)	60 ~ 120 seconds
Average Ramp Up Rate (Liquidus Temp (T_L) to Peak)		3 °C / second max.
$T_{S (max)}$ to T_L Ramp-up Rate		3 °C / second max.
Reflow	Temperature (T_L) (Liquidus)	217 °C
	Time (min to max) (t_L)	60 ~ 150 seconds
Peak Temperature (T_P)		260 ^{+0/-5} °C
Time of within 5 °C of Actual Peak Temperature (t_P)		20 ~ 40 seconds
Ramp-down Rate		6 °C / second max.
Time from 25 °C to Peak Temperature		8 Minutes max.
Do Not Exceed		260 °C

Flow/Wave Soldering (Solder Dipping)

Peak Temperature	260 °C+0 /- 5 °C
Dipping Time	10 seconds
Soldering Number	1 time

Packaging Information

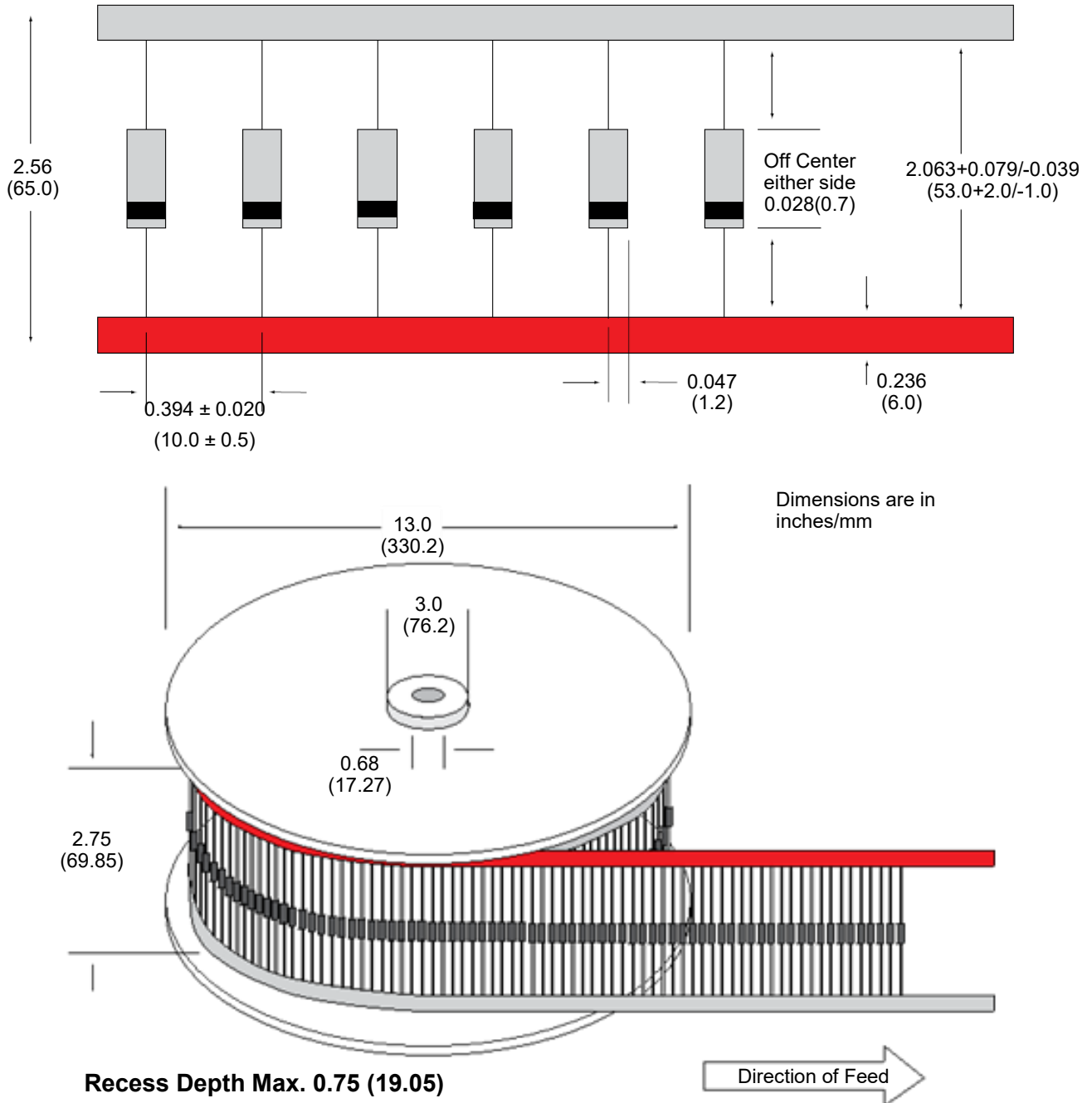

Part Number	Package	QTY's (Reel)	Packaging Option	Packaging Specification
1.5KExxxXX	DO-201	1200 PCS	Tape & Reel	EIA STD RS-296
1.5KExxxXX-TB	DO-201	1200 PCS	TB	/
1.5KExxxXX-B	DO-201	500 PCS	BULK	SETsafe SETfuse Spec

Glossary

Item	Description
V_C	Clamping Voltage Voltage across TVS in a region of low differential resistance that serves to limit the voltage across the device terminals.
V_R	Reverse Stand-off Voltage Maximum voltage that can be applied to the TVS without operation. NOTE : It is also shown as V_{WM} (maximum working voltage (maximum d.c. voltage)) and known as rated stand-off voltage (V_{so}).
I_R	Reverse Leakage Current Current measured at V_R . NOTE : Also shown as I_D for stand-by current.
V_{BR}	Breakdown Voltage Voltage across TVS at a specified current I_T in the breakdown region.
I_{PPM}	Rated Random Recurring Peak Impulse Current Maximum-rated value of random recurring peak impulse current that may be applied to a device.
$P_{M(AV)}$	Rated Average Power Dissipation Maximum-rated value of power dissipation resulting from all sources, including transients and standby current, averaged over a short period of time.
P_{PPM}	Rated Random Recurring Peak Impulse Power Dissipation Maximum-rated value of the product of rated random recurring peak impulse current (I_{PPM}) multiplies by specified maximum clamping voltage (V_C).
C_J	Capacitance Capacitance across the TVS measured at a specified frequency and voltage.
V_{FS}	Peak Forward Surge Voltage Peak voltage across an TVS for a specified forward surge current (I_{FS}) and time duration. NOTE : Also shown as V_F .
I_{FS}	Forward Surge Current Pulsed current through TVS in the forward conducting region. NOTE : Also shown as I_F .
$\alpha_{V(BR)}$	Temperature Coefficient of Breakdown Voltage The change of breakdown voltage divided by the change of temperature.
I_{PP}	Peak pulse Current Peak pulse current value applied across the TVS to determine the clamping voltage V_C for a specified wave shape.
I_T	Pulsed D.C. Test Current Test current for measurement of the breakdown voltage V_{BR} . This is defined by the manufacturer and usually given in milliamperes with a pulse duration of less than 40 ms. NOTE : Also shown as I_{BR} .

—(GB-T 18802.321 / IEC 61643-321 / JESD210A)



ATTENTION

Usage

1. TVS must be operated in the specified ambient temp.
2. Do not clean the TVS with strong polar solvent such as ketone, esters, benzene and halogenated hydrocarbon, to avoid damaging the encapsulating layer.
3. Please do not apply severe vibration, shock or pressure to TVS, to avoid element cracking.

Replacement

1. If TVS is visually damaged, please replace it.
2. TVS is a non-repairable product. For safety sake, please use equivalent TVS for replacement.

Storage

1. Storage Temp. Range: (-55 to 150) °C.
2. Do not store the TVS at the high temp., high humidity or corrosive gas environment, to avoid influencing the solder-ability of the lead wires. The product shall be used up within 1 year after receiving the goods.

Environmental Conditions

1. TVS should not be exposed to the open air, nor direct sunshine.
2. TVS should avoid rain, water vapor or other condition of high temp. and high humidity.
3. TVS should avoid sand dust, salt mist, or other harmful gases.

Max. Typical Capacitance of TVS

The typical capacitance of TVS is listed in the specifications. Designers may refer to it when designing TVS in High frequency circuit.

Installation Mechanical Stress

1. Do not knock TVS when installing, to avoid mechanical damage.
2. Please do not apply severe vibration, shock or pressure to TVS, to avoid surface resin or element cracking.

Transient Voltage Suppressor (Surface Mount) Features Overview

Package Type									Series
DO-221AC	<input type="checkbox"/>	<input type="checkbox"/>	<input type="checkbox"/>	<input type="checkbox"/>	<input type="checkbox"/>	SMA6L	<input type="checkbox"/>	<input type="checkbox"/>	<input type="checkbox"/>
DO-214AA	<input type="checkbox"/>	<input type="checkbox"/>	<input type="checkbox"/>	<input type="checkbox"/>	<input type="checkbox"/>	<input type="checkbox"/>	SACB	SMBJ	P6SMB
DO-214AB	<input type="checkbox"/>	<input type="checkbox"/>	<input type="checkbox"/>	<input type="checkbox"/>	<input type="checkbox"/>	<input type="checkbox"/>	<input type="checkbox"/>	<input type="checkbox"/>	<input type="checkbox"/>
DO-214AC	<input type="checkbox"/>	<input type="checkbox"/>	SMAJ	P4SMA	SMA6J	<input type="checkbox"/>	<input type="checkbox"/>	<input type="checkbox"/>	<input type="checkbox"/>
SOD-123FL	SMF	P4SMF	<input type="checkbox"/>	<input type="checkbox"/>	<input type="checkbox"/>	<input type="checkbox"/>	<input type="checkbox"/>	<input type="checkbox"/>	<input type="checkbox"/>
SMT0-218	<input type="checkbox"/>	<input type="checkbox"/>	<input type="checkbox"/>	<input type="checkbox"/>	<input type="checkbox"/>	<input type="checkbox"/>	<input type="checkbox"/>	<input type="checkbox"/>	<input type="checkbox"/>
Product Outline (mm)									
V_R / V_{WM} (V) Reverse Stand-off Voltage	5.0 ~ 250	5.0 ~ 85	5.0 ~ 440	5.8 ~ 468	5.0 ~ 250	5.0 ~ 50	5.0 ~ 440	5.8 ~ 512	
P_{PPM} (W) (10/1000 μ s) Rated Peak ImPulse Power Dissipation	200		400		600	500	600		
I_{PPM} (kA)(8/20 μ s) Rated Peak ImPulse Current					<input type="checkbox"/>				
Operating Temperature (°C)	-55 to +150								

Transient Voltage Suppressor (Surface Mount) Features Overview

Package Type	Series									
DO-221AC	○	○	○	○	○	○	○	○	○	○
DO-214AA	○	○	○	○	○	○	○	○	○	○
DO-214AB	SMCJ	1.5SMC	3.0SMCJ	SMDJ	5.0SMDJ	○	○	○	○	○
DO-214AC	○	○	○	○	○	○	○	○	○	○
SOD-123FL	○	○	○	○	○	○	○	○	○	○
SMT0-218	○	○	○	○	○	SPC1	SPC3	SPC6	SPC10	○
Product Outline (mm)										
$V_R / V_{WM} (V)$ Reverse Stand-off Voltage	5.0 ~ 440	5.8 ~ 512	5.0 ~ 440	12 ~ 170	380 / 430	66	58 ~ 76	58 ~ 86		
$P_{PPM} (W)$ (10/1000 μs) Rated Peak ImPulse Power Dissipation	1500		3000	5000			○			
$I_{PPM} (kA)$ (8/20 μs) Rated Peak ImPulse Current			○			1	3	6	10	
Operating Temperature (°C)			-55 to +150				-55 to +125			

Transient Voltage Suppressor (Axial Lead) Features Overview

Package Type	Series															
	DO-201	DO-41	DO-15	P600	Radial lead	1.5KE	LCE									
	○	○	○	○	○	○	○	○	○	○	○	○	○	○	○	○
	P4KE	○	○	○	○	○	○	○	○	○	○	○	○	○	○	○
	○	SAC	P6KE	○	○	○	○	○	○	○	○	○	○	○	○	○
	○	○	○	○	○	5KP	15KPA	20KPA	30KPA	○	○	○	○	○	○	○
	○	○	○	○	○	○	○	○	○	SPCL1	SPCL3	SPCL6	SPCL10	SPCL15	SPCL20	
Product Outline (mm)																
V_R / V_{WM} (V) Reverse Stand-off Voltage	5.8 ~ 468	5.0 ~ 50	5.8 ~ 512	5.8 ~ 512	6.5 ~ 90	5.0 ~ 250	17 ~ 280	20 ~ 300	28 ~ 360	76	15 ~ 430	30 ~ 430	15 ~ 530	58 ~ 380	16 ~ 76	
P_{PPM} (W) (10/1000 μ s) Rated Peak Impulse Power Dissipation	400	500	600	1500	5000	15000	20000	30000					○			
I_{PPM} (kA)(8/20 μ s) Rated Peak Impulse Current					○					1	3	6	10	15	20	
Operating Temperature (°C)					-55 to +150									-55 to +125		